

Notice To Owner

Waldoch offers a variety of van conversion packages. Some of the features described in this manual may not be included on your van. Check your feature-list to identify the specific features included in your Waldoch package. All packages subject to change without notice.

This manual is meant to supplement the owner's manual supplied by the chassis manufacturer and/or accessories manufacturers. Refer to these manuals for additional operating and maintenance information.

Table of Contents

INTRODUCTORY LETTER	3	Amenities	16, 17
WARRANTY INFORMATION	4, 5	Tissue Holder	16
REPORTING SAFETY DEFECTS	5	Drink Holders	16
SAFETY TIPS	6	Ashtrays	16
WALDOCH INTERIOR	7 - 17	Accessory Niches	16
Seating	7, 8, 9	12-volt Receptacle	16
Seat Adjustment	7	Garment Hooks	16
Power Seats	7	Clothes Hanging Brackets	16
Quick Release	8	Magazine Rack	16
Passenger Restraints	9	Fire Extinguisher	16
Sofa/Bed Operations	9	Storage	17
Drop-Back Sofa	9	Pockets	17
Pull-Out Sofa	9	Compartments	17
Bed Extensions	9	Under Sofa Storage	17
Electrical System	10 - 15	INTERIOR CARE	17, 18
Control Panels	10, 11	Wood Trim	17
Lighting	10, 12	Seats and Fabric Trim	17
Fog & Driving Lights	12	Cloth Seats and Fabric Trim	17
Aircraft/Center Lights	12	Leather Seats	17, 18
Rear Lights	12	Passenger Restraints	18
Indirect Lights	12	Carpeting	18
Fuse Replacement	12	Opaque Shades	18
Radar Detector	13	WALDOCH EXTERIOR	18, 19, 20
Television/		Roof Racks	18
Video Cassette Player	13	License Plate Step	18
Vacuum	14	Fog and Driving Lights	18
Compact Disc Player	14	Raised Roofs	19
Telephone-ready	14	Nose Guard	19
Radio	14	Running Boards	19
Speakers	14	Towing Packages	19
Headphones	14	Custom Wheels and Tires	19
Video Games	14	EXTERIOR CARE	20
Flexivision	15	Custom Paint and Vinyl Graphics	20
Rear Air Conditioning and		TROUBLESHOOTING	20, 21, 22
Heating Controls	15	OWNER ASSISTANCE	BACK COVER
Windows	15, 16		
Bay Window Operation	15		
Drapes	15		
Opaque Shades	16		

This information is subject to change without notice or legal obligation.

Waldoch Owner's Manual

Dear Waldoch Owner,

Thank you for choosing a Waldoch conversion.

Since 1974, the Waldoch Crafts team has been converting vehicles from mere modes of transportation to places of comfort and recreation. We hope you and your family will spend many hours enjoying the advantages of Waldoch travel.

To be sure that you receive the full benefits of each feature included in your Waldoch conversion, please read the following owner's manuals carefully. The easy-to-read instructions will explain the proper operation of each convenient Waldoch feature. Safety tips will help you take the necessary precautions to keep your family and passengers safe and sound. Cleaning and maintenance tips will ensure that your Waldoch will continue to attract envious attention for many years to come.

This manual is meant to supplement the owner's manuals provided by the chassis manufacturer and the various accessory manufacturers of your conversion vehicle's components. Please take time to read through all the literature included with your Waldoch.

We appreciate your confidence in selecting a Waldoch conversion. Through the years, Waldoch has put the fun into family traveling with quality workmanship and innovative design features. We hope you enjoy your conversion for years to come, as thousands of satisfied customers all over the country already do.

If you have any questions or would like additional information about your Waldoch, please call us at 1-800-328-9259. We'll be happy to provide any assistance or information you need.

Sincerely,



*Donald L. Waldoch
President*

Notice To Owner

Waldoch offers a variety of van conversion packages. Some of the features described in this manual may not be included on your van. Check your feature-list to identify the specific features included in your Waldoch package. All packages subject to change without notice.

This manual is meant to supplement the owner's manual supplied by the chassis manufacturer and/or accessories manufacturers. Refer to these manuals for additional operating and maintenance information.

Table of Contents

INTRODUCTORY LETTER	3	Amenities	16, 17
WARRANTY INFORMATION	4, 5	Tissue Holder	16
REPORTING SAFETY DEFECTS	5	Drink Holders	16
SAFETY TIPS	6	Ashtrays	16
WALDOCH INTERIOR	7 - 17	Accessory Niches	16
Seating	7, 8, 9	12-volt Receptacle	16
Seat Adjustment	7	Garment Hooks	16
Power Seats	7	Clothes Hanging Brackets	16
Quick Release	8	Magazine Rack	16
Passenger Restraints	9	Fire Extinguisher	16
Sofa/Bed Operations	9	Storage	17
Drop-Back Sofa	9	Pockets	17
Pull-Out Sofa	9	Compartments	17
Bed Extensions	9	Under Sofa Storage	17
Electrical System	10 - 15	INTERIOR CARE	17, 18
Control Panels	10, 11	Wood Trim	17
Lighting	10, 12	Seats and Fabric Trim	17
Fog & Driving Lights	12	Cloth Seats and Fabric Trim	17
Aircraft/Center Lights	12	Leather Seats	17, 18
Rear Lights	12	Passenger Restraints	18
Indirect Lights	12	Carpeting	18
Fuse Replacement	12	Opaque Shades	18
Radar Detector	13	WALDOCH EXTERIOR	18, 19, 20
Television/		Roof Racks	18
Video Cassette Player	13	License Plate Step	18
Vacuum	14	Fog and Driving Lights	18
Compact Disc Player	14	Raised Roofs	19
Telephone-ready	14	Nose Guard	19
Radio	14	Running Boards	19
Speakers	14	Towing Packages	19
Headphones	14	Custom Wheels and Tires	19
Video Games	14	EXTERIOR CARE	20
Flexivision	15	Custom Paint and Vinyl Graphics	20
Rear Air Conditioning and		TROUBLESHOOTING	20, 21, 22
Heating Controls	15	OWNER ASSISTANCE	BACK COVER
Windows	15, 16		
Bay Window Operation	15		
Drapes	15		
Opaque Shades	16		

This information is subject to change without notice or legal obligation.

Waldoch Owner's Manual

Dear Waldoch Owner,

Thank you for choosing a Waldoch conversion.

Since 1974, the Waldoch Crafts team has been converting vehicles from mere modes of transportation to places of comfort and recreation. We hope you and your family will spend many hours enjoying the advantages of Waldoch travel.

To be sure that you receive the full benefits of each feature included in your Waldoch conversion, please read the following owner's manuals carefully. The easy-to-read instructions will explain the proper operation of each convenient Waldoch feature. Safety tips will help you take the necessary precautions to keep your family and passengers safe and sound. Cleaning and maintenance tips will ensure that your Waldoch will continue to attract envious attention for many years to come.

This manual is meant to supplement the owner's manuals provided by the chassis manufacturer and the various accessory manufacturers of your conversion vehicle's components. Please take time to read through all the literature included with your Waldoch.

We appreciate your confidence in selecting a Waldoch conversion. Through the years, Waldoch has put the fun into family traveling with quality workmanship and innovative design features. We hope you enjoy your conversion for years to come, as thousands of satisfied customers all over the country already do.

If you have any questions or would like additional information about your Waldoch, please call us at 1-800-328-9259. We'll be happy to provide any assistance or information you need.

Sincerely,



*Donald L. Waldoch
President*

Warranty Information

LIMITED WARRANTY

Waldoch Crafts, Inc. warrants the parts and equipment for this vehicle against substantial defects in material and workmanship for a period of 36 months, or 36,000 miles, whichever comes first, from the date of the original purchase of the vehicle from the dealer, under normal use and service.

THIS LIMITED WARRANTY DOES NOT COVER:

1. Tires. Tires are subject only to the warranty provided by the tire manufacturer.
2. Equipment such as radios, televisions, video cassette players, compact disc players, radar detectors, custom seats, air conditioners, wheels or any others items which are individually guaranteed by their respective manufacturers. Waldoch Crafts, Inc. does not provide warranty for such items in addition to that provided by the manufacturers of such items.
3. Damage caused by misuse, accidents, negligence, overloading or ordinary wear and tear.
4. Consequential damages, including, but not limited to, inconvenience, loss of use of vehicle, transportation cost, loss of time, loss of income, lodging expenses, or loss or damage to personal property. (Because certain states do not permit the exclusions of incidental or consequential damages, the above limitation or exclusion may not be applicable to you.)

PROCEDURES RELATED TO WARRANTY WORK

In accordance with our dealer warranty policy, included with your Waldoch conversion, all warranty work must be approved in advance by an authorized representative. Waldoch Crafts, Inc. will not reimburse any dealer for labor or parts provided under this warranty unless approval for the specific work to be done and the amount to be charged is granted in advance by Waldoch Crafts, Inc.

TIME LIMITATIONS

As indicated above, this limited warranty extends to the original purchaser only, for a period of 36 months or 36,000 miles, whichever occurs first, from the date of original purchase of the vehicle from the dealer. In order for this warranty to become effective, all claims must be submitted to Waldoch Crafts, Inc. within such period and within 90 days of repair.

To the extent allowed by law, THIS WARRANTY IS IN PLACE OF ALL OTHER WARRANTIES, EXPRESS OR IMPLIED, INCLUDING ANY IMPLIED WARRANTY OF MERCHANTABILITY OF FITNESS. UNDER THIS WARRANTY, REPAIR OR REPLACEMENT PARTS BY WALDOCH CRAFTS, INC. IS THE ONLY REMEDY.

Warranty Information

WARRANTY REGISTRATION CARD

In order for this limited warranty to become effective, the registration card must be completed and mailed by your **Waldoch dealer** within 10 days of purchase to:

Waldoch Crafts, Inc.
13821 Lake Drive
Forest Lake, MN 55025

Sample registration card

WARRANTY REGISTRATION CARD

This registration card must be completed and mailed to Waldoch Crafts, Inc. 13821 Lake Drive, Forest Lake, MN 55025, within 10 days of purchase in order for this limited warranty to become effective.

Delivering Dealer _____ Dealer Salesperson _____
Dealer City, State _____
Customer Name _____
Customer Address _____
City, State, Zip _____
Phone _____

Reporting Safety Defects

The following is a statement written by the National Highway Traffic Safety Administration (NHTSA).

If you believe that your vehicle has a defect which could cause a crash or could cause injury or death, you should immediately inform the National Highway Traffic Safety Administration (NHTSA) in addition to notifying the chassis manufacturer and Waldoch Crafts, Inc.

If NHTSA receives similar complaints, it may open an investigation, and if it finds that a safety defect exists in a group of vehicles, it may order a recall and remedy campaign. However, NHTSA cannot become involved in individual problems between you, your dealer, the chassis manufacturer of Waldoch Crafts, Inc.

To contact Waldoch Crafts, Inc. call 1-800-328-9259 or write to Waldoch Crafts, Inc. 13821 Lake Drive, Forest Lake, MN 55025. To contact NHTSA, you may call either the Auto Safety Hotline toll free at 1-800-424-9393 (or 366-0123 in the Washington D.C. area) or write to: NHTSA, U.S. Department of Transportation, Washington D.C. 20590. You can also obtain other information about motor vehicle safety from the Hotline.

Safety Tips

Please take time to read your Waldoch owner's manual and the chassis manufacturer's owner's manual carefully, and become familiar with all the operations of your vehicle.

Because we care, we suggest following these important safety tips:

1. Please don't drink and drive.
2. Be sure the driver and passengers use safety restraints when the Waldoch is in motion. Approved car seats should be used for infants and young children.

Note: Inflating air bags can seriously injure small children. All children under 12 years old should always be placed in rear seats.

3. Do not allow anyone to lay on the sofa or ride in the storage space behind the sofa when your Waldoch is in motion.
4. Operate piston/mechanical bed extensions only from the rear doors of the vehicle. **Do not allow persons or excessive weight to be resting on the sofa or bed extension while in operation.**
5. Make sure that seats, sofa and entertainment console are all firmly locked in place when your Waldoch is in motion.
6. Make sure all luggage, books, sporting equipment, etc. is securely held in place in the storage net, pockets or compartments of your Waldoch when it is in motion.
7. Do not overload your Waldoch. Overloading can cause damage to the suspension, tires and wheels as well as affect performance. If carrying or towing heavy loads, check your axle weight (located on a sticker on the front driver door jamb). Make sure any carried weight is distributed evenly on both sides of the vehicle to insure its best performance. Check tires for proper inflation.

Note: Check the gross vehicle weight of your Waldoch (located on a sticker on the front driver door jamb), add any carried weight, and be aware of the total weight when traveling on roads or bridges with weight limits.

8. Check clearances on any overhead obstructions like parking ramp entrances, garage doors, low hanging wires, etc.
9. Keep rear windows free of obstruction and make sure rear blinds are open when driving your Waldoch. Factory-installed outside mirrors will help you safely maneuver your vehicle. Consult your chassis manufacturer's owner's manual regarding their operation.

Thank you for observing these safety tips. They will help insure the time spent in your Waldoch will be safe and enjoyable for all!

Your Waldoch Interior

SEATING

All Waldoch seats are engineered and tested to provide maximum comfort and safety for you and your passengers. Seats come in a variety of styles and fabrics.

SEAT ADJUSTMENT

Using the levers designated below, your seats can be moved forward and back, reclined or swiveled for maximum comfort:

Move forward and back. This lever is located underneath the front of each seat. Move the lever and adjust the seat forward or back. Release the lever to lock in place.

Recline. This lever is located on the side of the seat toward the rear. Lift the lever and lean back to adjust to the desired reclining position. Release the lever to lock in place. To return seat to upright position, lift lever and lean forward. The seat will automatically return to the upright position. Release the lever to lock in place.

Swivel. The two center seats of most full-size Waldochs have this adjustment. This lever is located on the right side of the seat, toward the front. Lift lever up and forward and rotate the seat to the desired position. Seats lock into place only when they are facing forward.

Adjustable Arm Rests. Lever is located on the front of each arm rest.

Note: Seats should be locked in the forward facing position when the van is in motion.

POWER SEATS

If your Waldoch is equipped with power seats, the control panel is located on the side or front of each seat.

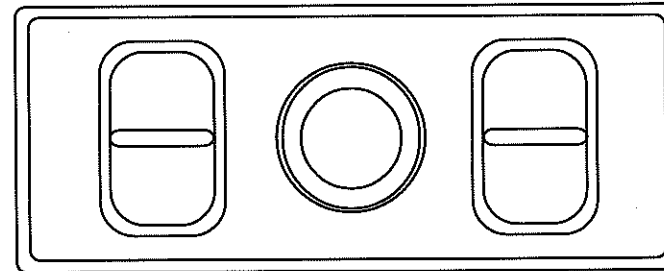

Front Button:
to move seat front height up and down.

Center Button:
to move seat base forward, back, up and down.

Rear Button:
to move seat rear height up and down.

Your Waldoch Interior

QUICK RELEASE

The center seats on most Waldochs are quick release. To remove the two center seats from your Waldoch, follow these steps:

1. Using your passenger restraint Quick Release (found on the upper part of the shoulder harness), release the shoulder harness from the sidewall by lifting tab on the forward side of shoulder belt upper anchor and sliding the belt out of the anchor.
2. Find the Quick Release lever on the outside of the seat pedestal. Press the lever down, allowing you to pull the lock system forward all the way.
3. Tilt the seat backward, then remove it by lifting it up and forward.

Note: You may require assistance in removing the seat from the vehicle, as it weighs approximately 55 pounds.

4. Re-lock the lock mechanism under the lever to prevent accidental bending.

To reinstall, simply reverse the steps 1, 2 and 3 above.

Note: For your safety, please be sure all seats are facing forward and locked securely in place when vehicle is in motion.

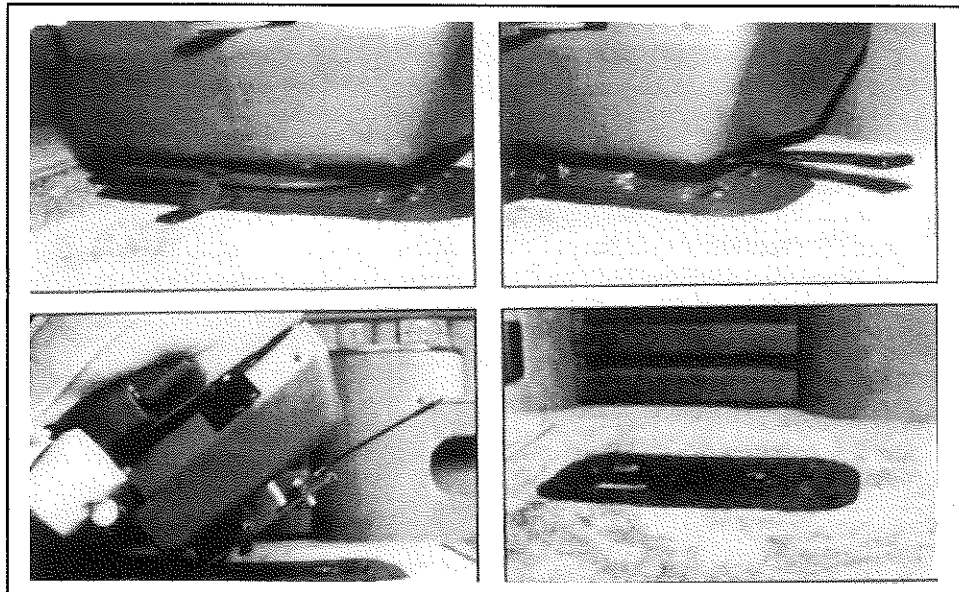

Your Waldoch Interior

PASSENGER RESTRAINTS

The seat belts and shoulder harnesses in your Waldoch are designed and installed to meet or exceed Federal Motor Vehicle Safety Standards. Passenger restraints on the center seats are equipped with a Quick Release function (see previous page), to be used only for the purpose of removing seats from the vehicle.

Note: Approved car seats should be used for infants and young children. For your safety, please be sure all passengers are buckled in when your Waldoch is in motion. Inflating air bags can seriously injure small children. All children under 12 years old should always be placed in rear seats.

SOFA/BED OPERATIONS

Your Waldoch may be equipped with a Drop-Back, Pull-Out or Power Sofa. Convert your sofa to a bed according to the instructions below:

Drop-Back Sofa. There are levers on both the right and left sides of the sofa. Pull up on one of the levers and push the sofa back into the fully-reclined position. After returning the sofa to an upright position, be sure that the levers and sofa are locked in place.

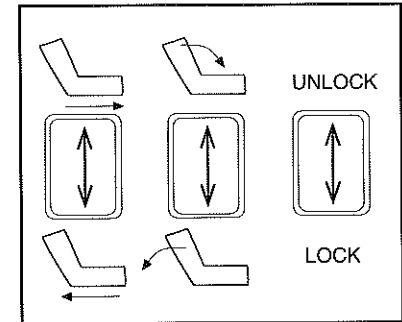

Note: Remove headrest before dropping sofa back.

Pull-Out Sofa. There is a lever at the middle front of the sofa seat. Pull the lever forward to slide the sofa bottom into the fully-reclined position. After returning the sofa to the upright position, be sure that the lever is locked in place.

Power Sofa. See control panel diagrams for recline and slide switch locations. To operate the recline switch or slide switch, simply push down and hold until the couch is in the desired position, then release.

Note: Do not attempt to convert sofas with persons or excessive weight resting on them.

BED EXTENSIONS

Two different types of bed extensions, either piston/mechanical-mounted or modular, may be included with your Waldoch. Piston/mechanical-mounted extensions are attached directly to the back of your sofa. Modular extension rests on its own four legs, and can be easily removed to provide additional hauling space.

Note: Operate piston/mechanical bed extensions only from the rear doors of your Waldoch. Do not allow persons or excessive weight to be resting on the sofa or bed extension while in operation. This could cause damage to seat and seat motor.

Your Waldoch Interior

ELECTRICAL SYSTEM

Important: All Waldochs feature a special safety disable, interior power switch which is located on your dash or overhead console. This switch shuts the power off or on to your Waldoch electrical components such as your interior lights. This switch allows you to shut off the interior lights when doors are opened. A low battery detection circuit will shut off all switched outputs if the battery voltage drops below 10 volts. The system draws zero current in the off state.

Operating Instructions. The switch panels supplied in this vehicle have been designed to provide you with a lifetime of trouble-free switching. Each switch panel is back lighted. Back lighting will come on whenever ignition is in the accessory or on positions. Please take a moment to review the operation and valuable features of your system.

- **Interior Lighting Switching.** These circuits are powered by the vehicles ignition key on position, or while the vehicle is in operation. Push the switch once to activate the desired function; the switch lens will turn green to indicate the "on" function. Push the switch again to turn-off the function; the green switch lens will go off when deactivated.
- **Rear Fan Control.** For models equipped with auxiliary heating and air conditioning, the control is located in the mid-section of the driver's side between the windows. **This control is only operable when dash fan control is in the off or rear control position. Otherwise, the auxiliary heat/air fan is controlled by dash fan control.**
- **Power Sofa Control. (Optional)** To move the sofa forward or back (slide) activate and hold the designated switch until you have adjusted the sofa to the desired position. To move the sofa up or down (recline), activate and hold the designated switch until you have adjusted the sofa to the desired position.
- **Door Lock.** To activate door lock function, push designated switch to lock and unlock vehicle doors. Many vehicles also have factory-supplied rear door locks.
- **Automatic Interior Light Delay.** A convenient feature when entering or exiting a vehicle in poorly lighted areas, the automatic interior light delay provides pre-selected interior lighting that will stay on for up to 60 seconds after the last door is closed, or until the vehicle ignition is turned on. TV/radio power and indirect lighting continues for up to 20 minutes after ignition is switched off.

Your Waldoch Interior

Master Control Panels

Depending on the features included on your Waldoch van, one of these types of master panel controls will be located on your overhead console or sidewall.

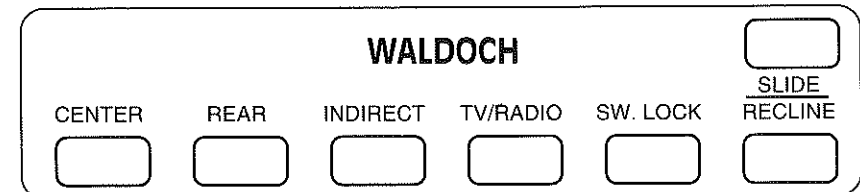

Summit LX and Boundary Waters control panel.

Low battery light (red) will appear in upper left corner if battery voltage drops below 10 volts.

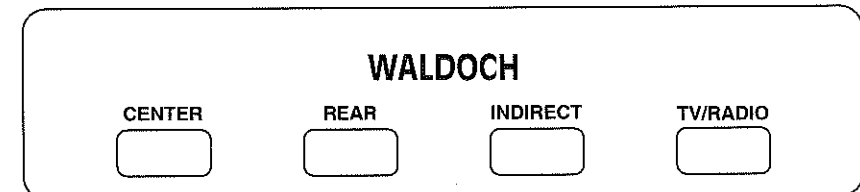

Control panel for all other models.

Low battery light (red) will appear in upper left corner if battery voltage drops below 10-volts.

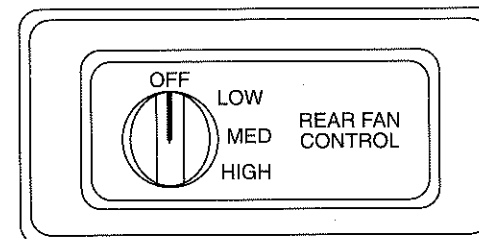
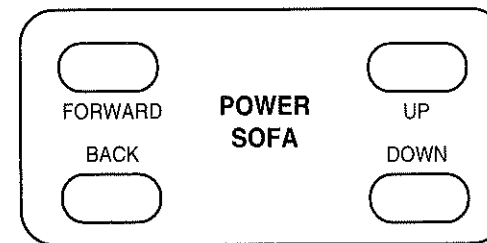

AT-FAN-002 (REAR CONTROL)

S.W. Lock Switch

In the on position, will disable all rear auxiliary lighting switch panels.

Power Sofa Control (optional)

To move the sofa forward or back (slide), activate and hold the designated switch until you have adjusted the sofa to the desired position. To move the sofa up or down (recline), activate and hold the designated switch until you have adjusted the sofa to the desired position.

Note: Do not attempt to convert sofas with persons or excessive weight resting on them.

Rear Fan Control

To activate rear fan, turn control knob to the desired fan speed. Remember, this control is only operable when dash fan control is in the off or rear control position.

Note: Do not use any sharp objects or harsh detergents to clean the surface of the switch panels, this may result in damage to the surface or operation of the switches, and void product warranty. Only use a soft, dry cloth to wipe the panel surfaces.

Your Waldoch Interior

LIGHTING

Fog and Driving Lights. Controls for these lights can be found on a separate light switch panel on the front dashboard or control console. Fog lights work only with low beam; driving lights only on high beam. Adjustment of fog lights and driving lights can be done yourself to meet your own driving needs and conditions.

Important: Covers must be removed from these lights before operating to prevent overheating and melting.

Aircraft/Center Lights. These lights are located along the overhead center panel of your Waldoch. See control panel diagrams for switch locations. Center lights can also be operated by their local switches, provided that the control panel switch is in the "on" position.

Rear Lights. These lights are located along the overhead center panel at the rear of your Waldoch. See control panel diagrams for switch locations. Rear lights can also be operated by their local switches provided that the master control panels is in the "on" position.

Indirect Lights. Your Waldoch may be equipped with indirect lights under window valances and/or along the length of the center overhead panel. See control panel diagrams for switch locations.

Interior Lights Disable Switch. When off, this switch prevents interior lights from going on when the doors are open. If doors will be left open for a long period of time, it should be used to avoid drawing off the van's battery. The switch is located on the front dash or overhead console.

FUSE REPLACEMENT

The fuse box for the Waldoch electrical system will be located on the wall behind the driver's seat. The system uses standard automotive fuses, and amperage for each fuse is identified on the fuse panel. Be sure to check these fuses if any of the auxiliary lighting or electrical components are not working.

Note: When replacing fuses, use only fuses that meet maximum amp limits.

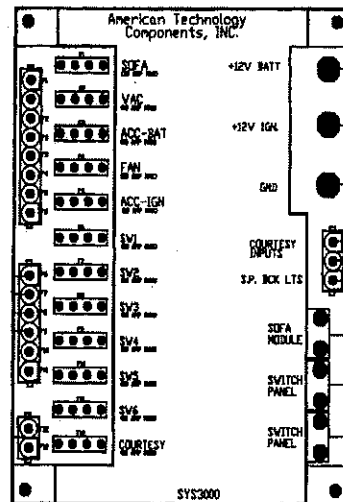

Your Waldoch Interior

RADAR DETECTOR

If a front drop down, overhead compartment is included in your Waldoch, it will house either a radar detector or a 12-volt receptacle ready for radar detector or storage. See your individual product owner's manual for details on the operation of your radar detector. The overhead compartment may be manually pulled open and pushed close. This compartment is suitable for storing wallets, keys or other valuables out of sight.

Note: Check state laws regarding the legality of using a radar detector.

TELEVISION/VIDEO CASSETTE PLAYER

Your Waldoch may be equipped with a television and/or video cassette player, located either in an entertainment console between the front seats or overhead. Both can be operated only if the TV/Radio switch is in the "on" position. See control panel diagram for switch location. Remote controls for the television and video cassette player are located in owner's packet. See individual product owner's manual for details on the operation of your television and video cassette player.

The speaker for the television and video cassette player is located overhead in the center of the vehicle to provide easy listening to all passengers. A driver control button for the television and video cassette player is located on the front of the entertainment console. It can be used to switch the external speaker on and off.

Note: Television is designed to only work in conjunction with VCP while a video tape is playing.

SURROUND SOUND

Vehicles equipped with Surround Sound will not have the center mounted speaker. The rear speaker control switch is located on the dash. See Surround Sound owner's manual for operating instructions.

To remove the TV, VCP and entertainment console from the van:

1. Release metal latches on both sides of entertainment console.
2. Unscrew the antenna cable under seat if present.
Note: Because most antennas are in console, no disconnection is required.
3. Unplug 12-volt receptacle located under your seat.
4. Unplug speaker wire connection.
5. If your Waldoch is equipped with Surround Sound, you will be required to unscrew knob on the back of cabinet to gain access to gray headphone out plug from the headphone out plug on back of TV. Disconnect plug.

To reinstall, simply reverse the above steps.

Note: Please make sure that the entertainment console is locked securely in place to prevent shifting when the Waldoch van is in motion.

Your Waldoch Interior

VACUUM

Your Waldoch may be equipped with a hand-held vacuum either mounted on the right rear wall behind the sofa or stored in one of the rear modular storage compartments. The vacuum can be plugged into any 12-volt receptacle in your Waldoch. See individual product owner's manual for details on the operation of your hand-held vacuum.

COMPACT DISC PLAYER

If your conversion is equipped with a compact disc player, it will be mounted in the rear. A lighted display on dash panel controls the CD player. See the CD owner's packet for operations details.

TELEPHONE-READY

If your Waldoch is telephone-ready, your telephone antenna and 12-volt receptacle will be located under the driver's seat or on the left sidewall.

RADIO

If your Waldoch includes an auxiliary rear radio, it will be mounted on the left sidewall. The rear radio can only be operated if the master control TV/Radio switch is in the "on" position and can only be heard through the rear headphones, unless equipped with Surround Sound. See control panel diagram for switch location. See individual product owner's manual for details on the operation of your rear radio.

Speakers. Speakers for the factory-installed front radio may be located in the front doors or dash, in the vehicle's midsection, or in the rear. Speakers may be factory-installed.

Headphones. Headphone jacks are located behind the center seats on both sides of the van. Two sets of headphones are included. There are separate plugs for TV/VCP and radio headphones.

VIDEO GAMES

All Waldoch televisions are compatible with Nintendo, Super Nintendo and SEGA. A switch attachment is needed to operate the games. Check the back of your television for such a switch, or call the Waldoch Parts and Accessories Department for details on making your television compatible for these video games.

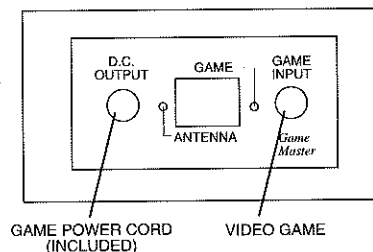

FLEXVISION

Flexvision is a separate and additional system to the standard TV package found in Waldoch conversions. Flexvision offers 2 or 4 individual TV screens mounted in seat backs. This allows each rear passenger to select individual viewing or listening choices for TV, VCP, Super Nintendo or radio. See the Flexvision owner's manual for additional information.

Note: Flexvision is only compatible with Super Nintendo.

Your Waldoch Interior

POWER MIRRORS

Power mirrors included with your vehicle are factory-installed. See your chassis manufacturer's owner's manual for details on their operation.

ELECTRIC REAR VIEW MIRRORS

Optional mirrors include a compass, outside temperature reading and two map lights. Control switch is located on top of mirror.

REAR AIR CONDITIONING AND HEATING CONTROLS

If your Waldoch is equipped with rear A/C and heating controls, they will run off the vehicle's compressor and the temperature will be regulated through the driver's dash controls. Fan controls are located on the dash and the mid section of the driver's side between the windows. (See page 10-11 for Rear Fan Control).

Note: See chassis owner's manual for correct type of refrigerant to use in air conditioning unit and for proper maintenance schedule.

BAY WINDOW OPERATION

Pull latch out, then slide panel forward to open screen. Pull latch out, then slide panel back to close. Release latch to lock window in place.

Note: Sliding windows may experience some water seepage if impacted by high-pressure sprayers, such as those in a car wash. They are designed to drain via outside vents when this occurs.

OPAQUE SHADES

Your Waldoch is equipped with opaque shades. To operate shades, gently slide them up and down. When not in use, shades should be left in the up position to keep folds well-creased.

Caution: These shades are delicate features and should not be used as door handles or for support when entering or exiting your vehicle.

Note: In full-size Chevy vans, rear cargo door shades must be kept in the down position when opening and closing rear cargo doors.

Remember: When contacting Waldoch Crafts for assistance, please refer to the vehicle identification number (VIN) found on the identification tag located on the front passenger door jamb, or on a plate on the left front corner of the dash, visible through the windshield. Include this number in any calls or correspondence involving your Waldoch conversion.

Your Waldoch Interior

OTHER AMENITIES

Tissue Holder. A standard-size tissue holder may be located in the front of the entertainment console. A smaller-size tissue holder may be included on the side cargo door.

Drink Holders. Drink holders are located in the front or sidewall consoles.

Ashtrays. Additional ashtrays are located in the sidewall consoles.

Accessory Niches. Accessory niches, in which to place remote controls or other items, are located in the front or sidewall consoles.

12-volt Receptacle. An auxiliary 12-volt receptacle is located in the left sidewall console.

Garment Hooks. A garment hook is mounted on the right front sidewall.

Clothes Hanging Brackets. Retractable clothes hanging brackets are mounted in the rear of your Waldoch overhead behind the sofa.

Magazine Rack. A magazine rack is attached to the left sidewall, in the middle of your Waldoch.

Fire Extinguisher. Your Waldoch may be equipped with a fire extinguisher, located in one of the rear modular storage compartments.

Note: To purchase and/or to add any of the amenities list above, call the Waldoch Parts and Accessories Department at 800-328-9259 or 612-464-3215.

STORAGE

Your Waldoch offers a great deal of convenient storage space throughout its interior.

Pockets. Convenient automotive pockets, located on seat backs and side doors can hold a variety of things. Overloading these compartments, however, may cause them to stretch and lose their elasticity.

Compartments. Rear modular storage compartments are ideal for storage. The front overhead storage nets are suitable for storing keys, wallets, or valuables out of sight.

Under Sofa Storage. Depending on the type of sofa in your Waldoch van, there may be additional storage space under your sofa. *Make sure, however, that any items stored under the sofa do not interfere with the sofa's operation, or remove the items before converting the sofa into the bed position or operating the power slide feature.*

Interior Care

WOOD TRIM

All wood components in a Waldoch are made of solid, high-quality, true-grained wood. We choose our wood from select grade walnut, and design all our wood accessories ourselves, in our state-of-the-art wood shop. Some checking, cracks, knots, grain variations and other characteristics are expected and naturally enhance the beauty of the wood.

All wood in your Waldoch is sealed for appearance, preservation and long life. Provide the same care for this wood as you do for the wood in your home by periodically cleaning it with a wood polish-and-scratch remover.

Note: The walnut finish will bleach where exposed to sunlight. This newly finished wood product will appear darker than the wood already in your vehicle. As this luxurious new piece of wood ages it will be enhanced as it is exposed to sunlight, and will lighten to become a beautiful addition to your vehicle.

SEATS AND FABRIC TRIM

Cloth Seats and Fabric Trim. The cloth seats and fabric trim in your Waldoch are both soil and stain resistant - most spills can be removed with a damp cloth. For more serious stains, use a high quality upholstery cleaner.

Leather Seats. Genuine leather seats may bear slight striations, grain irregularities or other natural characteristic of leather which enhances its beauty.

Note: For vehicles with tilt steering, always tilt the steering wheel all the way up when getting out of your vehicle to prevent excessive wear on the driver's seat.

More Interior Care

LEATHER SEATS (CONTINUED)

Leather seats are treated to protect against dirt and water stains. Dust and clean your leather seating regularly using a quality leather cleaner. Waldoch Parts and Accessories Department carries several.

Note: Never use furniture polish, oil, varnish, ammonia or anything abrasive to clean leather surfaces.

PASSENGER RESTRAINTS

If the seat belts or shoulder harnesses in your Waldoch become soiled, they can be cleaned with mild soap and water, using a sponge or brush.

CARPETING

The carpeting in your Waldoch is stain resistant - most spills can be removed with a damp cloth. For more serious stains, use a high quality carpet cleaner.

OPAQUE SHADES

Light cleaning of the shades in your Waldoch is best done with the brush attachment of a vacuum.

Your Waldoch Exterior

ROOF RACKS

Your Waldoch may be equipped with an aerodynamic roof rack.

There are many accessories available for the aerodynamic rack, including ski, bicycle, and sailboard carriers. Call our Waldoch Parts and Accessories Department for more information about ordering these accessories.

Note: Be sure to check clearance when passing under parking ramp entrances, garage doors, low hanging wires and any overhead obstructions.

LICENSE PLATE STEP

Your Waldoch may be equipped with a front license plate step to assist with checking engine fluid levels, washing the windshield, etc. Black nylon steps prevent corrosion and maintain an excellent appearance. To operate the bumper step, pull the front plate down and lock the latch into the groove on the step.

Note: When using the bumper step, make certain that the latch is locked securely in place to prevent the step from returning to the closed position.

FOG AND DRIVING LIGHTS

Controls for these lights can be found on a separate light switch panel on the front dashboard or control console. Fog lights work only with low beam; driving lights only on high beam. Adjustment of fog lights and driving lights can be done yourself to meet your own driving needs and conditions.

Important: Covers must be removed from these lights before operating to prevent overheating and melting.

Your Waldoch Exterior

RAISED ROOFS

Note: If your vehicle is equipped with a raised roof option, be sure to check clearance when passing under parking ramp entrances, garage doors, low hanging wires and any overhead obstructions.

NOSE GUARD/HOOD SHIELDS

Your Waldoch may be equipped with an aerodynamically-designed nose guard. It is mounted on the hood of your Waldoch to help protect from bugs, rocks and road debris.

RUNNING BOARDS

Your conversion may be equipped with aluminum or fiberglass running boards. When entering or exiting your vehicle, only step tread areas should be used.

TOWING PACKAGES

Waldoch vans may be equipped for towing. Consult your chassis manufacturer's owner's manual for your vehicle's load rating. Then call the Waldoch Parts and Accessories Department for more information about selecting the proper hitch for your vehicle.

CUSTOM WHEELS AND TIRES

Your Waldoch may be equipped with aftermarket tires and wheels. Check tires for proper pressure. Refer to manufacturer's limited warranty and individual product owner's manual.

CUSTOM WHEELS CARE

We recommend you use mild soap and water or a wheel-cleaning product that is designed for your type of wheel. Follow these tips to keep custom wheels properly maintained:

1. First, allow your wheels to cool down before cleaning. Cleaning hot wheels can cause brake dust to stain wheels.
2. Make sure you've selected the right car care products for your vehicle. Read and follow directions carefully.
3. Clean one wheel at a time to prevent cleaner from drying on wheels and becoming difficult to rinse off. Rinse wheels completely.
4. Enhance and protect your custom wheels by applying a coat of paste wax after cleaning.
5. For heavy accumulations of road grime, corrosion, etc. use a soft bottle-cleaning type brush to clean custom wheels. Be careful of brushes with hard or stiff bristles - they may scratch the surface.

If you live in areas where road salts are used during winter months, we suggest maintaining your wheels on a more frequent basis during this time. The ingredients in road salt may harm the finish of your wheels if not properly maintained. Products available through Waldoch Parts and Accessories Department include: Cleaning Kit (cleaner and neutralizer), Mag Cleaner, All Finish Cleaner, Mag and Chrome Polish, and Aluminum Wash and Brightener.

Note: Some aftermarket custom wheels have lug nuts that do not fit the manufacturer's lug wrench that the vehicle is equipped with from the factory. In such cases, Waldoch provides the correct lug nut wrench.

Exterior Care

CUSTOM PAINT AND CUSTOM VINYL GRAPHICS

Waldoch exterior paint and vinyl graphics are applied using the very finest materials. To keep your Waldoch finish clean and shiny, wash it regularly using a mild automotive detergent. For added protection, you may want to occasionally apply a high quality car wax. Do not use any type of abrasive cleaners on the exterior of your Waldoch - they will scratch the fine finish. If you have additional questions regarding the exterior of your Waldoch, please contact our Waldoch Parts and Accessories Department.

Note: Please wait at least 30 days before applying any finish protection product to the exterior of your Waldoch.

 SHERWIN Williams	
AUTOMOTIVE FINISHES	
<input type="radio"/>	Ultra 7000™ ACRYLIC URETHANE
<input type="radio"/>	Ultra Free™ NON-ISOCYANATE SYSTEM
<input type="radio"/>	ULTRA ONE STAGE™ ACRYLIC URETHANE SYSTEM
Color 1.	
Color 2.	
Color 3.	
Color 4.	
Color 5.	
Date Painted:	
Painted by:	

Troubleshooting

- Interior courtesy lights do not light.**
1. Make sure disable switch is on.
 2. Make sure switch is on at the individual light.
 3. Check fuse in fuse board.
 4. If lights do not go off, ensure headlight switch is not turned fully to the left.

- Power sofa does not slide or recline.**
1. Check behind and underneath the sofa for items that may be obstructing operation and movement.
 2. Check vehicle battery for full charge. If not, slow-charge vehicle battery to a full charge.
 3. Check fuse in fuse board.

Troubleshooting

- Rear heat and air conditioning fan will not operate.**
1. Check power switch on overhead control panel.
 2. Check to make sure factory controls are in the "on" position.
 3. Check fuse in fuse board.

- Rear heat and air conditioning will not heat or cool**
1. Heating/cooling slide control lever on dash must be at maximum heating or cooling level.
 2. Check coolant level in radiator.
 3. Have your dealer check refrigerant charge and thermostat.

- Compact disc player does not play.**
1. Check to make sure cartridge is inserted properly in player.
 2. Check to make sure discs are inserted into cartridge with label up.
 3. Make sure dash radio is turned to 88.3 FM and the power is on.

- Rear radio does not play.**
1. Make sure headphones are operating correctly (see headphone section below).
 2. Check fuse in fuse board.
 3. Ensure TV/radio switch on control console is in "on" position.

Note: Rear radio is designed to operate with sound directed only through the headphones. There is no external speaker for this unit. If headphones are plugged directly into the radio, the rear headphone jacks will not function.

- Headphones do not work.**
1. Make sure component (rear radio or television) is turned on.
 2. Make sure headphone plug is inserted all the way in.
 3. Make sure headphones are not plugged directly into radio.
 4. Check connections at TV console.

- No power to entertainment console.**
1. Ensure TV switch on control console is in "on" position.
 2. Make sure TV/VCP is connected.
 3. Check fuse in fuse board.

Troubleshooting

Television or video cassette player cuts out during operation.

1. Make sure connections are securely fastened.
2. Check to be sure vehicle battery is fully charged. If not, slow-charge vehicle battery to a full charge.

Video cassette picture does not appear on television.

1. Make sure video cassette is rewound.
2. Make sure video cassette player is operating on "play" and power is on.
3. Make sure TV is in "video" mode.

Remote control units do not work.

1. Make sure main power is on at the component and overhead control panel.
2. Make sure you are using the correct remote control for the component you are operating.
3. Make sure batteries are inserted properly.

Power seats do not work.

1. Check around and under seat for items which might be obstructing operation and movement.
2. Check all wiring connection to the seat.
3. Check in-line fuse.

Notes